

6A, 17V, ACOT[®] High-Efficiency Synchronous Step-Down Converter Evaluation Board

General Description

This user guide contains information for the RTQ2806A DC-DC converter. Also included are the performance specifications, the schematic, and the list of materials for the RTQ2806A.

Table of Contents

General Description	1
Performance Specification Summary	2
Power-up Procedure	2
Detailed Description of Hardware	3
Bill of Materials.....	5
Typical Applications	6
Evaluation Board Layout.....	10
More Information.....	13
Important Notice for Richtek Evaluation Board.....	13

Performance Specification Summary

A summary of the RTQ2806A Evaluation Board performance specification is provided in Table 1. The ambient temperature is 25°C.

Table 1. RTQ2806A Evaluation Board Performance Specification Summary

Specification	Test Conditions	Min	Typ	Max	Unit
Input Voltage Range		3.5	12	17	V
Output Current		0	--	6	A
Default Output Voltage		--	1.8	--	V
Operation Frequency		--	1100	--	kHz
Output Ripple Voltage	I _{OUT} = 6A	--	10	--	mVp-p
Line Regulation	I _{OUT} = 3A, V _{IN} = 3.5V to 17V	--	±0.5	--	%
Load Regulation	V _{IN} = 12V, I _{OUT} = 0.001A to 6A	--	±0.5	--	%
Load Transient Response	I _{OUT} = 10mA to 6A	--	±5	--	%
Maximum Efficiency	V _{IN} = 12V, V _{OUT} = 1.8V, I _{OUT} = 6A	--	89.6	--	%

Power-up Procedure

Suggestion Required Equipments

- RTQ2806A Evaluation Board
- DC power supply capable of at least 17V and 7A
- Electronic load capable of 6A
- Function Generator
- Oscilloscope

Quick Start Procedures

The Evaluation Board is fully assembled and tested. Follow the steps below to verify board operation. Do not turn on supplies until all connections are made. When measuring the output voltage ripple, care must be taken to avoid a long ground lead on the oscilloscope probe. Measure the output voltage ripple by touching the probe tip and ground ring directly across the last output capacitor.

Proper measurement equipment setup and follow the procedure below.

- 1) With power off, connect the input power supply to the VIN and GND pins.
- 2) With power off, connect the electronic load between the VOUT and nearest GND pins.
- 3) Turn on the power supply at the input. Make sure that the input voltage does not exceeds 17V on the Evaluation Board.
- 4) Check for the proper output voltage using a voltmeter.
- 5) Once the proper output voltage is established, adjust the load within the operating ranges and observe the output voltage regulation, ripple voltage, efficiency, and other performance.

Detailed Description of Hardware

Headers Description and Placement

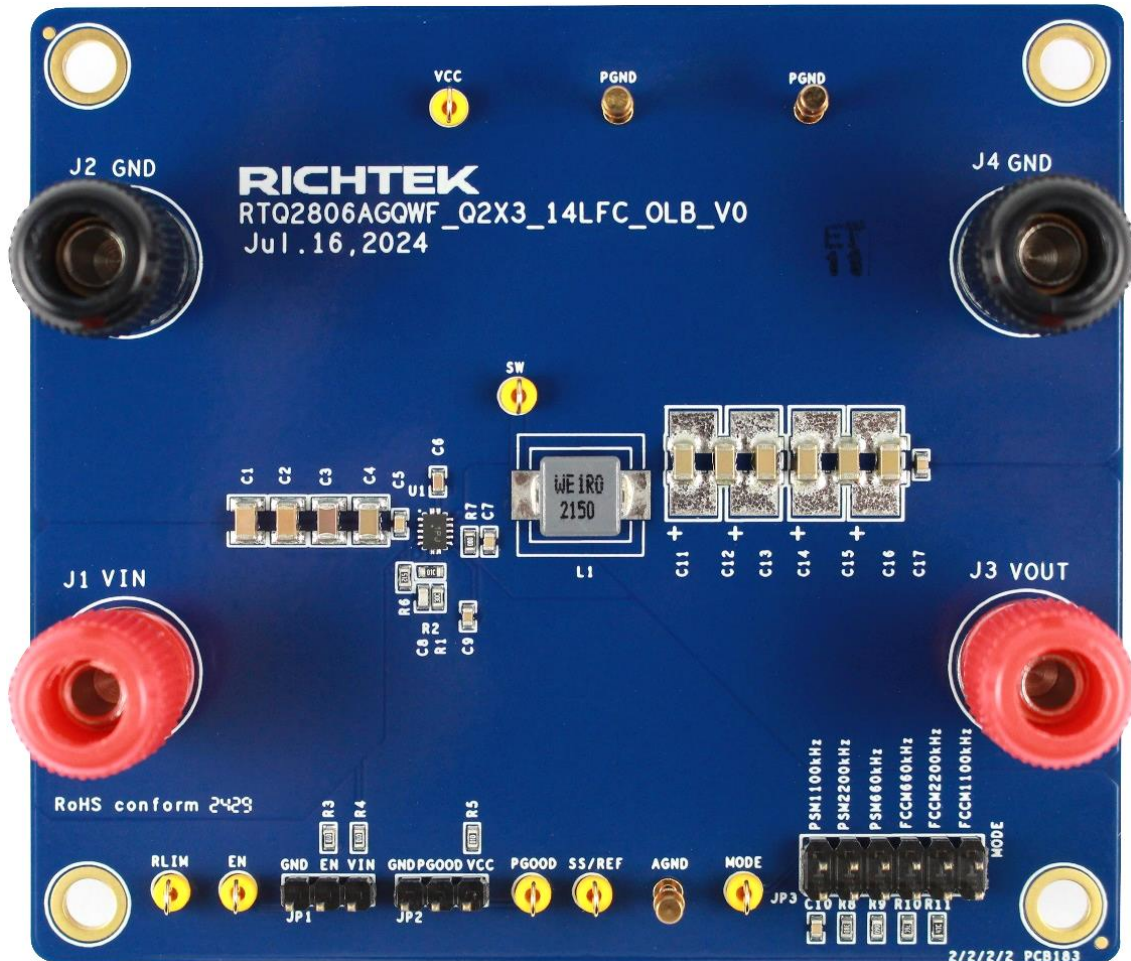

Carefully inspect all the components used in the EVB according to the following Bill of Materials table, and then make sure all the components are undamaged and correctly installed. If there is any missing or damaged component, which may occur during transportation, please contact our distributors or e-mail us at evb_service@richtek.com.

Test Points

The EVB is provided with the test points and pin names listed in the table below.

Test Point/ Pin Name	Function
J1	VIN input voltage connector
J2	PGND connection for input
J3	VOUT output voltage connector
J4	PGND connection for output
JP1	Connects EN to VIN to enable the device.
JP2	Connects PGOOD to VCC through a 100kΩ.
JP3	Mode selection
EN	EN test point
SS/REF	Can be used to monitor the reference voltage.
VCC	VCC test point
PGOOD	PGOOD output test point
MODE	Mode selection test point
RLIM	Can be used to monitor the voltage level of the valley current limit.
SW	Switch node test point

Bill of Materials

VIN = 12V, VOUT = 1.8V, IOUT = 6A, fsw = 1100kHz						
Reference	Count	Part Number	Value	Description	Package	Manufacturer
U1	1	RTQ2806AGQWF	--	Step-Down Converter	WQFN-14TL 2x3 (FC)	RICHTEK
L1	1	74437346010	1μH	Inductor, Isat = 29A, 10mΩ	--	Würth Elektronik
C1, C2	2	GRM31CR71E106KA12L	10μF	Capacitor, Ceramic, 25V, X7R	1206	MURATA
C3, C4	2	GRM31CR71H475KA12L	4.7μF	Capacitor, Ceramic, 50V, X7R	1206	MURATA
C5, C7, C10, C17	2	C1608X7R1H104KT000N	0.1μF	Capacitor, Ceramic, 50V, X7R	0603	TDK
C6	1	GRM188R61E475KE11D	4.7μF	Capacitor, Ceramic, 25V, X5R	0603	MURATA
C8	1	0603N331J500CT	330pF	Capacitor, Ceramic, 50V, NPO	0603	WALSIN
C9	1	GRM188R71H223KA01D	22nF	Capacitor, Ceramic, 50V, X7R	0603	MURATA
C11, C12, C13, C14, C15, C16	6	GRM31CR60J476ME19L	47μF	Capacitor, Ceramic, 6.3V, X5R	1206	MURATA
R1	1	WR06X2002FTL	20k	Resistor, Chip, 1/10W, 1%	0603	WALSIN
R2	1	WR06X1002FTL	10k	Resistor, Chip, 1/10W, 1%	0603	WALSIN
R3, R4, R5	3	WR06X1003FTL	100k	Resistor, Chip, 1/10W, 1%	0603	WALSIN
R6	1	RC0603FR-075K1L	5.1k	Resistor, Chip, 1/10W, 1%	0603	YAGEO
R7	1	WR06X000 PTL	0	Resistor, Chip, 1/10W, 1%	0603	WALSIN
R8	1	WR06X2433FTL	243k	Resistor, Chip, 1/10W, 1%	0603	WALSIN
R9	1	RTT031213FTP	121k	Resistor, Chip, 1/10W, 1%	0603	RALEC
R10	1	CR0603F60K4P05Z	60.4k	Resistor, Chip, 1/10W, 1%	0603	EVER OHMS
R11	1	RTT033012FTP	30.1k	Resistor, Chip, 1/10W, 1%	0603	RALEC

Typical Applications

EVB Schematic Diagram

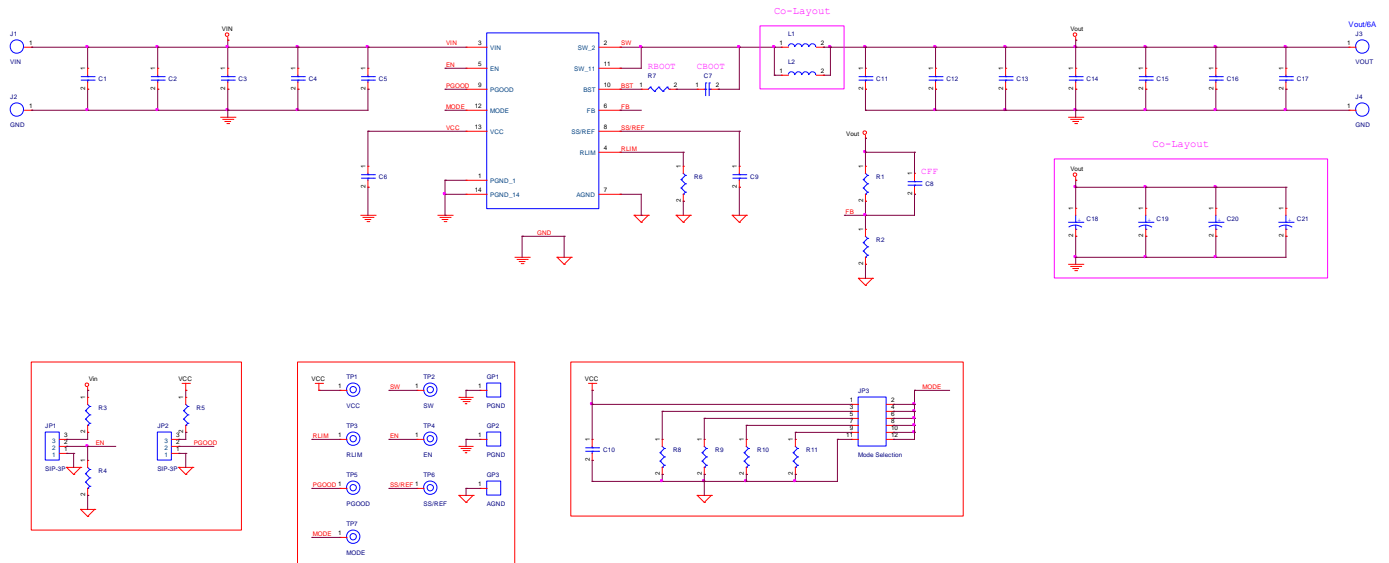

1. The capacitance values of the input and output capacitors will influence the input and output voltage ripple.
2. MLCC capacitors have degrading capacitance at DC bias voltage, and especially smaller size MLCC capacitors will have much lower capacitance.

Measure Result

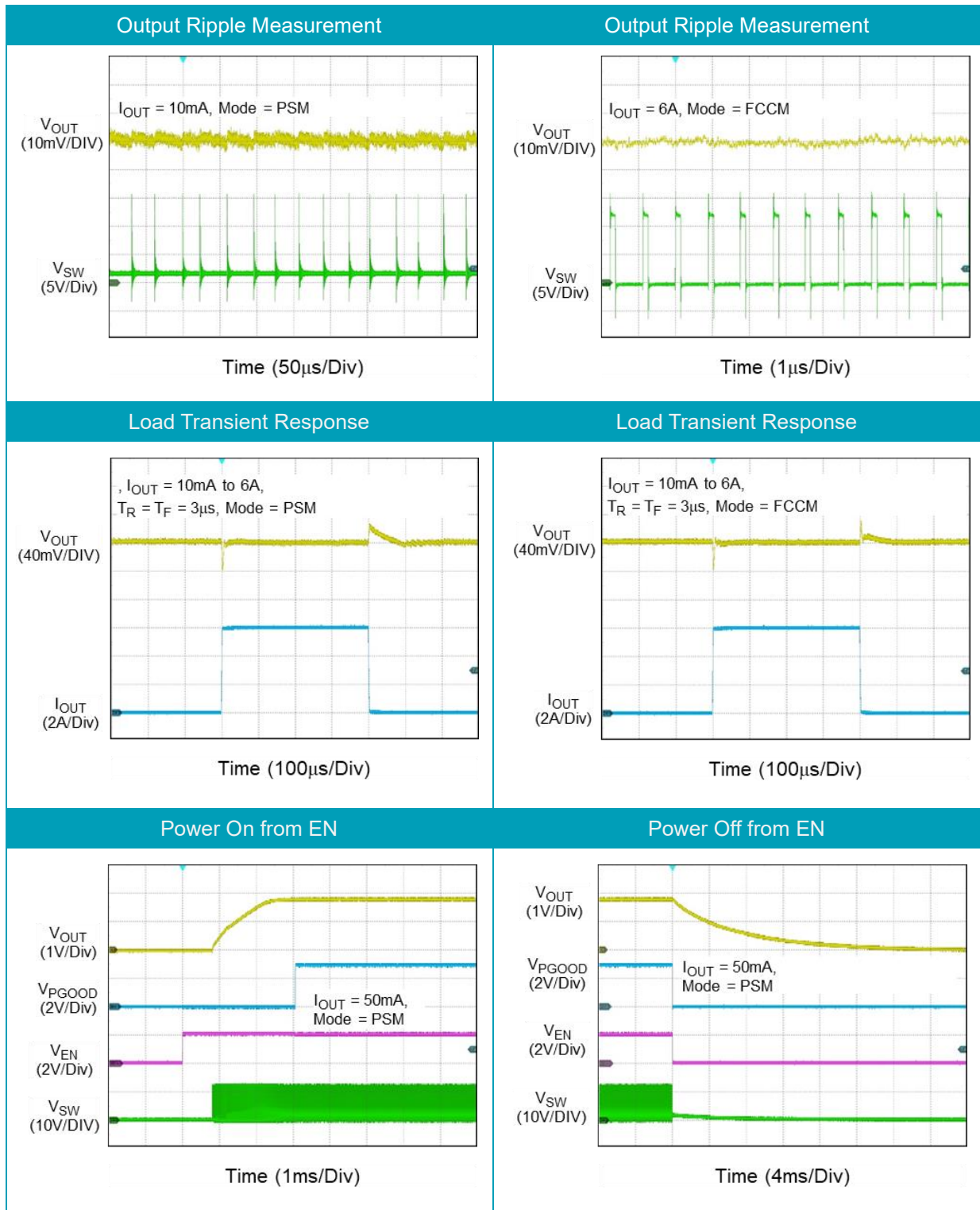

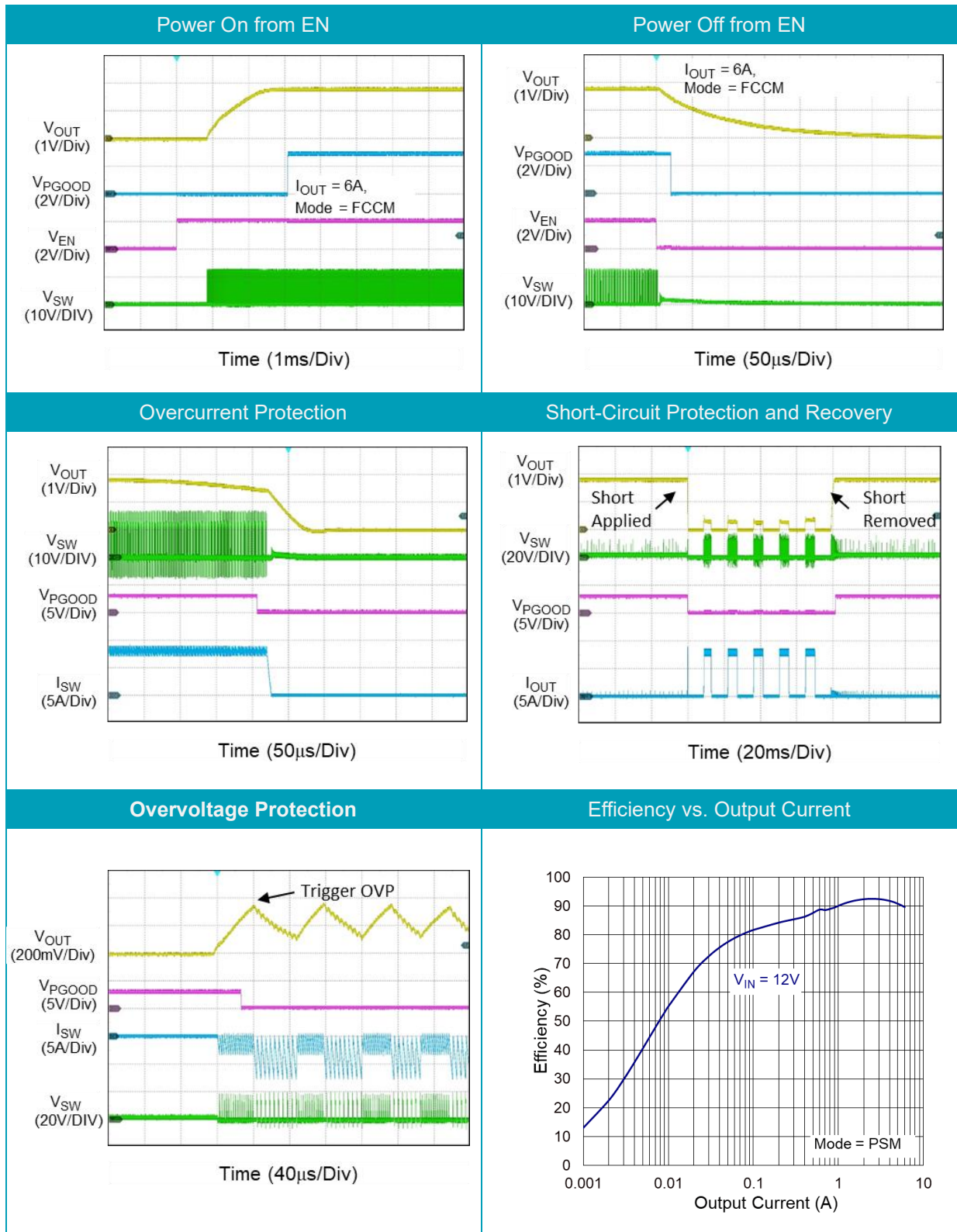

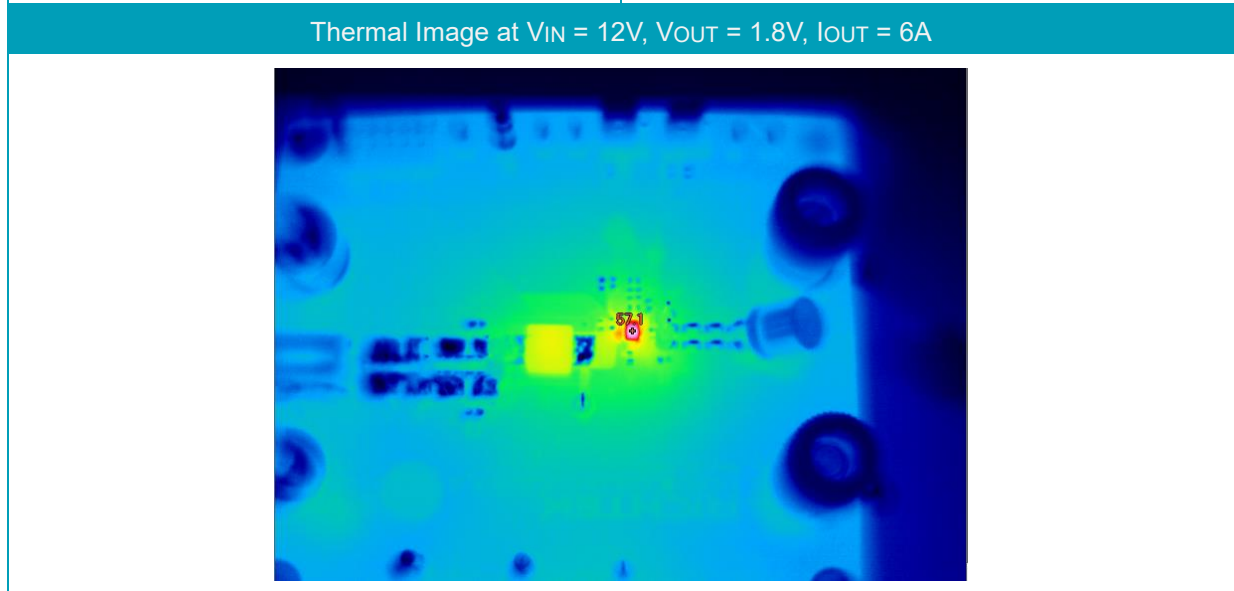
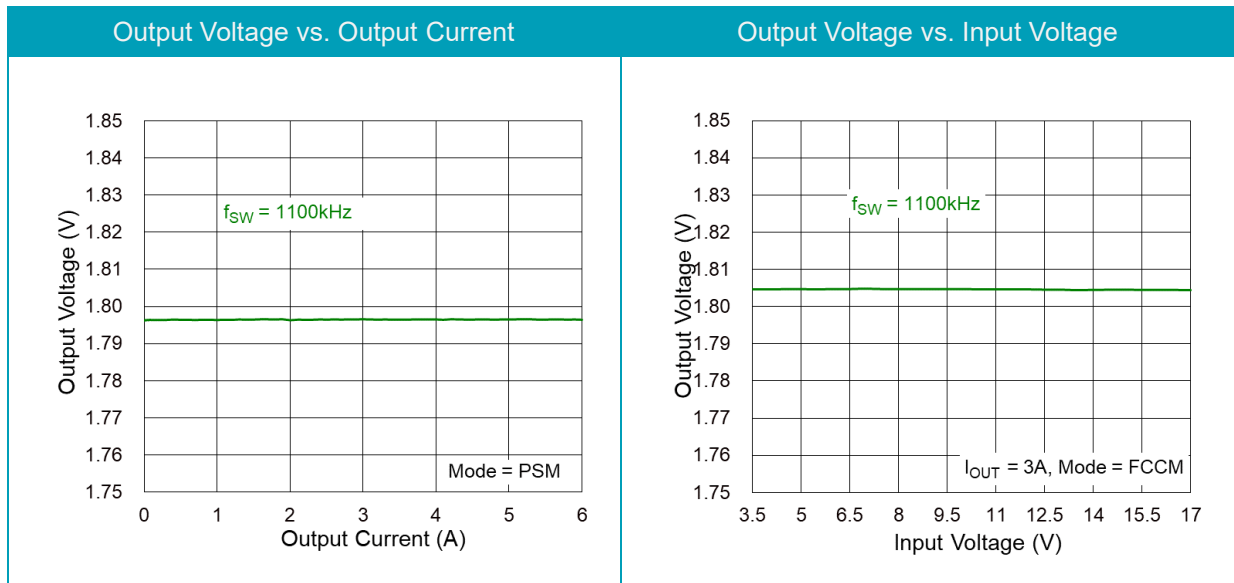

Note: Care must be taken to avoid a long ground lead on the oscilloscope probe when measuring the input or output voltage ripple. Measure the output voltage ripple by touching the probe tip directly across the output capacitor.

Evaluation Board Layout

Figures 1 to 4 show the RTQ2806A Evaluation Board layout. This board size is 85mm x 80mm and is constructed on a four-layer PCB, with outer layers of 2 oz. Cu and inner layers with 2 oz. Cu.

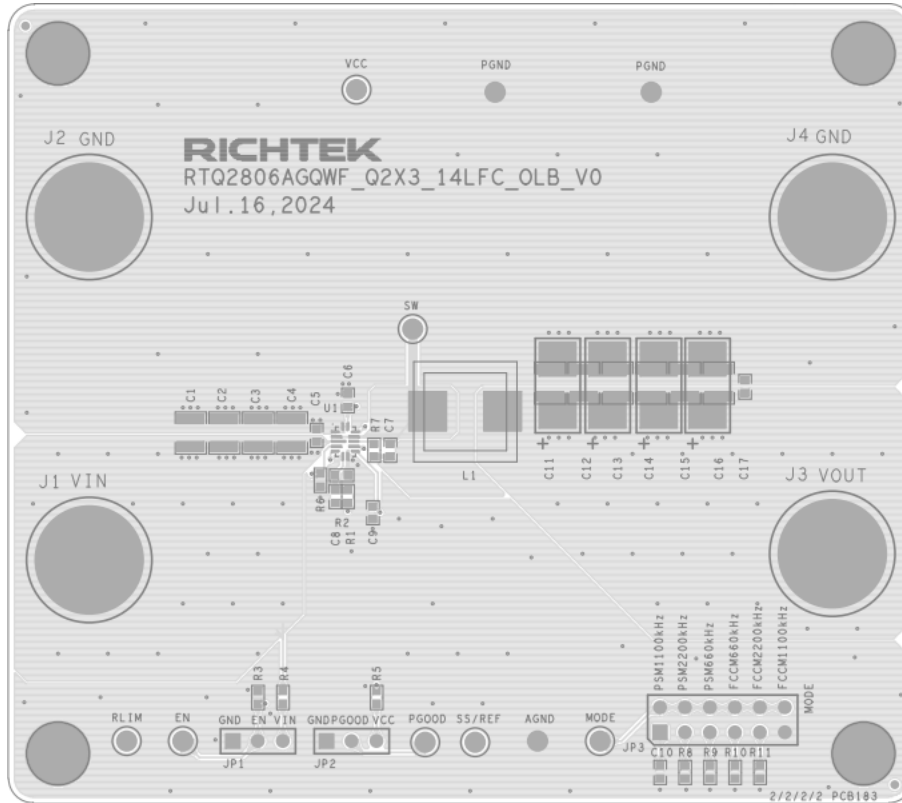

Figure 1. Top View (1st layer)

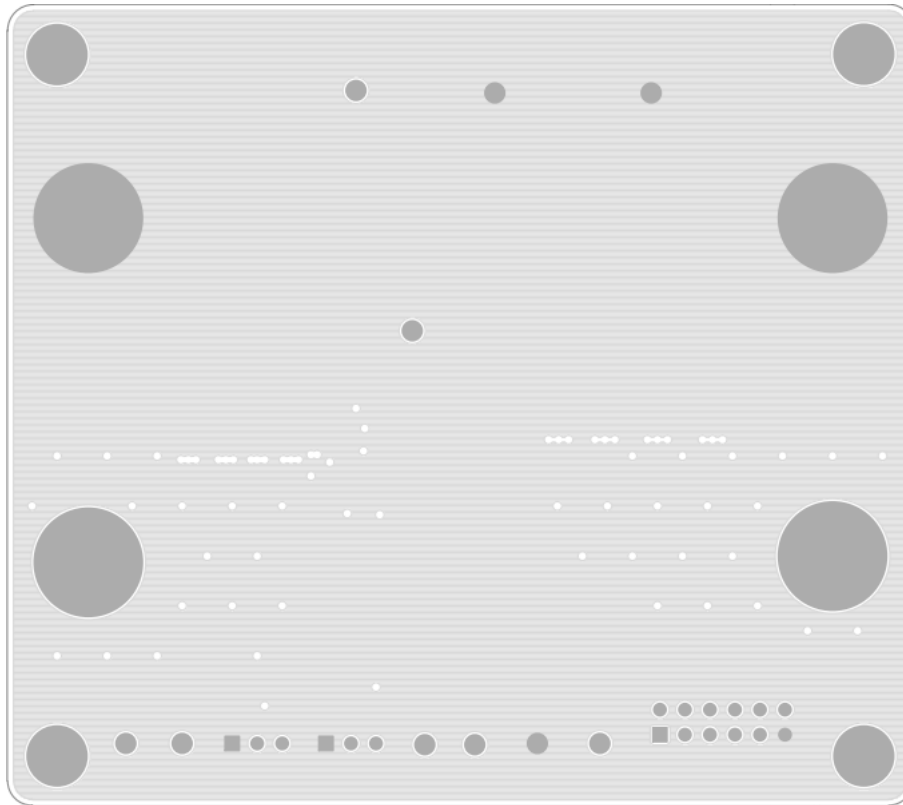

Figure 2. PCB Layout—Inner Side (2nd Layer)

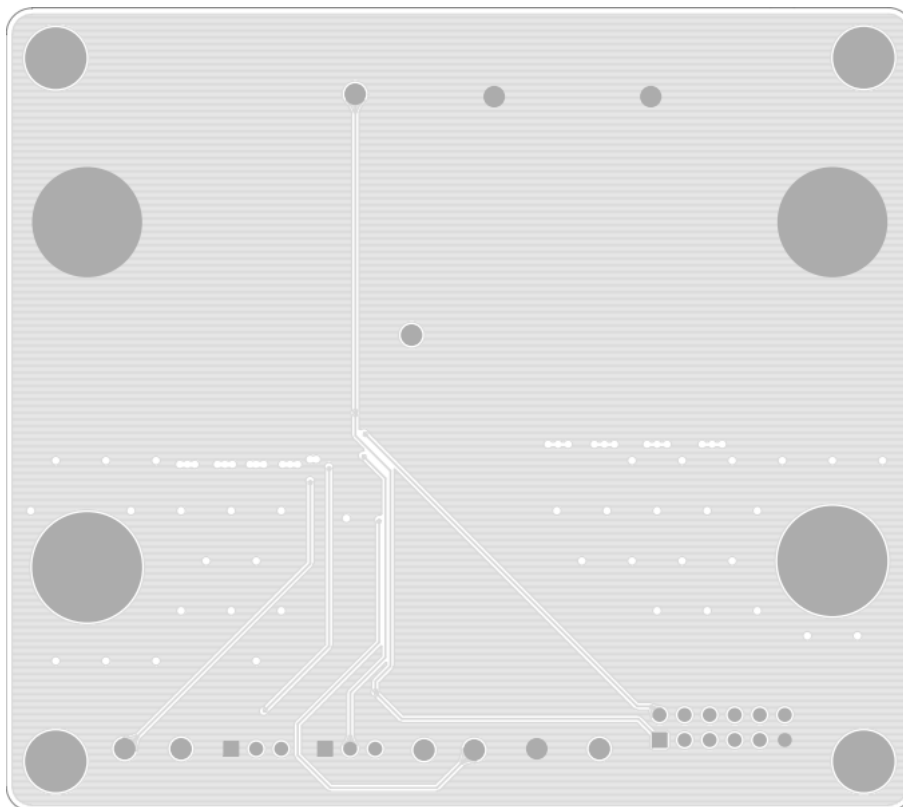

Figure 3. PCB Layout—Inner Side (3rd Layer)

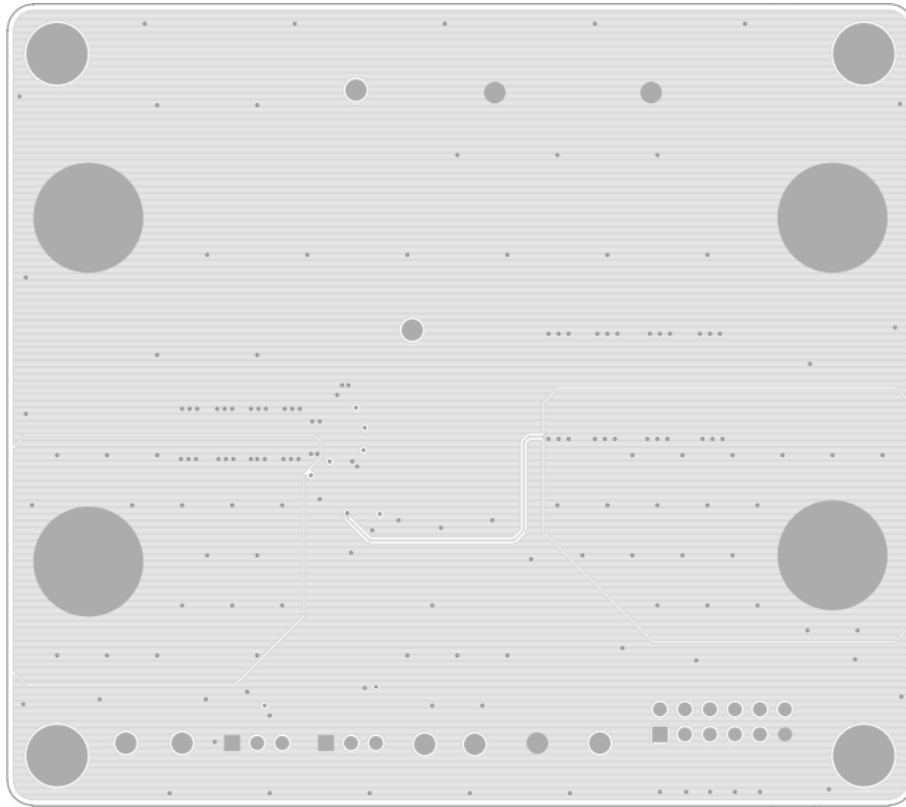

Figure 4. Bottom View (4th Layer)

More Information

For more information, please find the related datasheet or application notes from Richtek website

<http://www.richtek.com>.

Important Notice for Richtek Evaluation Board

THIS DOCUMENT IS FOR REFERENCE ONLY, NOTHING CONTAINED IN THIS DOCUMENT SHALL BE CONSTRUED AS RICHTEK'S WARRANTY, EXPRESS OR IMPLIED, UNDER CONTRACT, TORT OR STATUTORY, WITH RESPECT TO THE PRESENTATION HEREIN. IN NO EVENT SHALL RICHTEK BE LIABLE TO BUYER OR USER FOR ANY AND ALL DAMAGES INCLUDING WITHOUT LIMITATION TO DIRECT, INDIRECT, SPECIAL, PUNITIVE OR CONSEQUENTIAL DAMAGES.